

electriQ

USER MANUAL

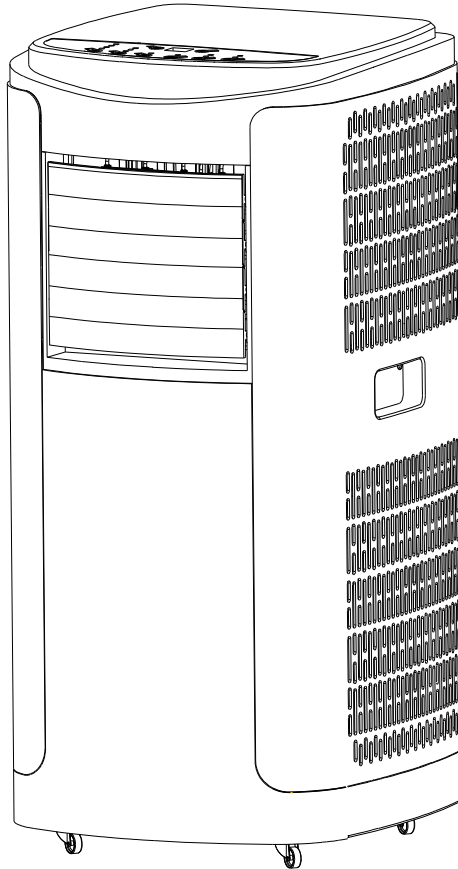

electriQ PORTABLE AIR CONDITIONER

P12C	12,000 BTU
P15C	14,000 BTU

Thank you for choosing electriQ

Please read this user manual before using this innovative Air Conditioner and keep it safe for future reference.

Visit our page www.electriQ.co.uk for our entire range of Intelligent Electricals

CONTENTS

SAFETY INFORMATION	2
FEATURES	5
PARTS LIST	5
INSTALLATION	6
OPERATION	8
REMOTE CONTROL	9
EMPTYING THE INTERNAL WATER TANK	10
CLEANING AND MAINTENANCE	11
TROUBLESHOOTING	12
ERROR CODES	12
SUPPORT	13
TECHNICAL SPECIFICATION	14

SAFETY INSTRUCTIONS



Important!

- Carefully read the instructions before operating the unit
- This appliance is for indoor use only.
- Rating: This unit must be only connected to a 220-240 V / 50 Hz earthed outlet.
- Installation must be in accordance with regulations of the country where the unit is used.
- If you are in any doubt about the suitability of your electrical supply have it checked and, if necessary, modified by a qualified electrician.
- This air conditioner has been tested and is safe to use. However, as with any electrical appliance - use it with care.
- Disconnect the power from the appliance before dismantling, assembling or cleaning.
- Avoid touching any moving parts of the appliance.
- Never insert fingers, pencils or any other objects through the guard
- This appliance is not intended for use by persons (including children) with reduced physical, sensory or mental capabilities. It is also not intended for use by those with a lack of experience and knowledge, unless they have been given supervision or instruction concerning the use of the appliance by a person responsible for their safety.
- Do not leave children unsupervised with this appliance.
- Do not clean the unit by spraying it or immersing it in water.
- Never connect the unit to an electrical outlet using an extension cord. If an outlet is not available, one should be installed by a qualified electrician.
- Never operate this appliance if the cord or plug is damaged. Ensure the power cord is not stretched or exposed to sharp objects/edges.
- A damaged supply cord should be replaced by the manufacturer or a qualified electrician in order to avoid a hazard.
- Any service other than regular cleaning or filter replacement should be performed by an authorised service representative. Failure to comply could result in a voided warranty.
- Do not use the appliance for any purpose other than its intended use.
- **The air conditioner unit must always be stored and transported upright, otherwise irreparable damage may be caused to the compressor; if in doubt we suggest waiting at least 24 hours before starting the unit.**
- Avoid restarting the air conditioning unit unless 3 minutes have passed since being turned off. This prevents damage to the compressor.
- Never use the mains plug as a switch to start and turn off the air conditioning unit. Use the provided ON/OFF button located on the control panel.
- Always place the unit on a dry and stable surface.
- The appliance should not be installed in laundry or wet rooms.
- The appliance must be placed in a room without sources of ignition (for example: open flames, an operating gas appliance or an operating electric heater).

- R290 refrigerant gas complies with European environmental directives.
- R290 has a low GWP (Global Warming Potential) of 3.
- The air conditioners contain around 280 g of R290 refrigerant gas.
- Do not use or store in an unventilated space with an area smaller than 13.4 m² per unit.
- The room must be such as to prevent stagnation of possible leaks of refrigerant gas as there could be a danger of fire or explosion should the refrigerant come into contact with electric heaters, stoves or other sources of ignition.
- Refrigerant gas may be odourless.
- Do not use the product and contact the retailer for advice, if damage has occurred to the unit which may have compromised the refrigerant system.
- Any repairs or maintenance must only be carried out on the unit by a suitably qualified engineer. Before opening and servicing the unit the authorised engineer must be in possession of a copy of the manufacturer's service manual and must follow the safety information contained within it to ensure all hazards are minimized.
- The refrigerant system should not be perforated or punctured.

Energy Saving and Unit Safety Protection Tips

- Do not cover or restrict the airflow from the outlet or inlet grills.
- For maximum performance the minimum distance from a wall or objects should be 50cm.
- Keep the filters clean. Under normal conditions, filters should only need cleaning once every three weeks (approximately). Since the filters remove airborne particles, more frequent cleaning may be necessary, depending on the air quality.
- For the initial start-up set the fan speed to maximum and the thermostat to 5 degrees lower than the current temperature. After, set the fan switch to low and set the thermostat to your desired setting.
- To protect the unit, we recommend not using the cooling function when the ambient temperature is higher than 38°C.

FEATURES

- 3 in 1 Cooling, Fan, Dehumidifier. The P12C is great for Rooms up to 30 m² and the P15C for rooms upto 38m².
- 3 speed fan: Balancing quiet operation with performance.
- 24 Hours Start / Stop Timer.
- Digital Thermostat.
- Remote Control.
- Castors for Enhanced Portability.

PARTS LIST

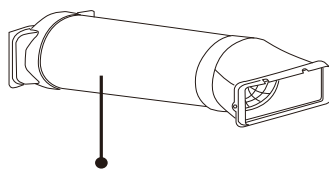
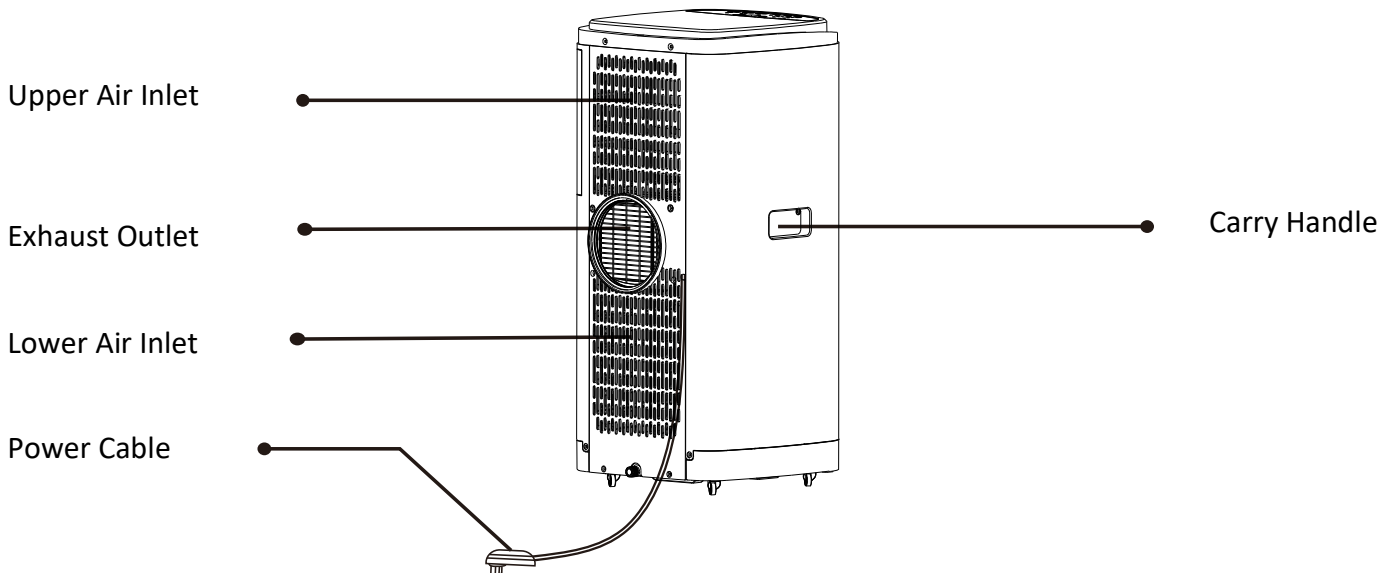
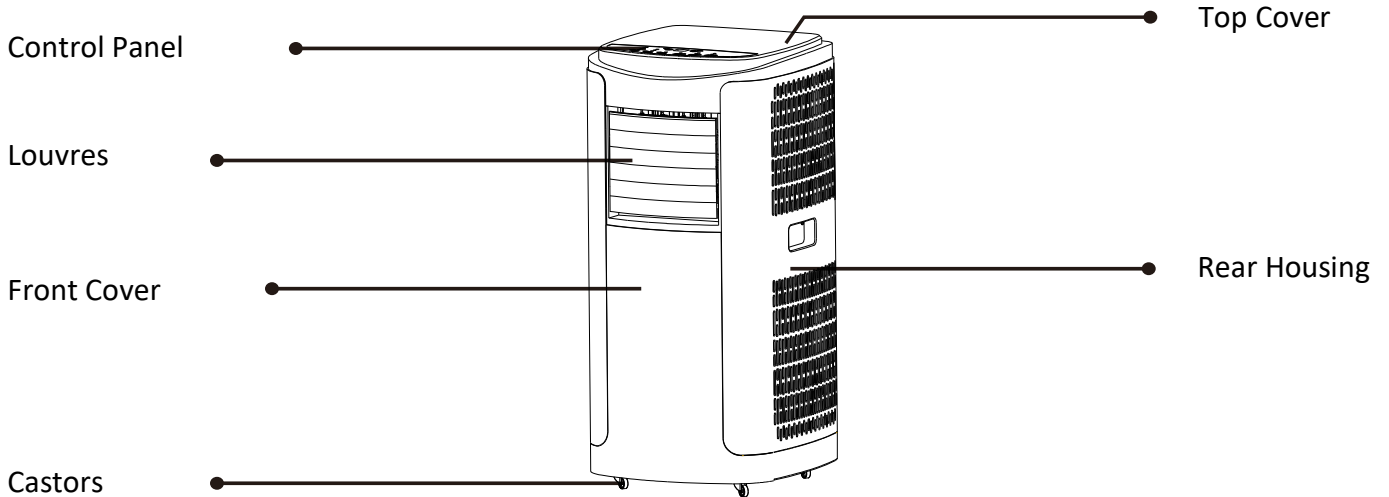

Exhaust Hose*

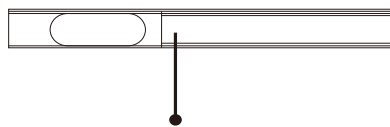

Window Slide Bar*

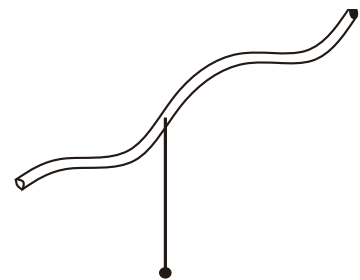

Drainage Pipe*

* Note: Diagrams of accessories are for illustrative purposes only, actual design may vary.

INSTALLATION

WARNING: Before using this unit, please keep it upright for at least 3-4 hours.

This unit can easily be moved from one room to another. While moving the unit please note that it must always be kept upright and then placed on an even surface.

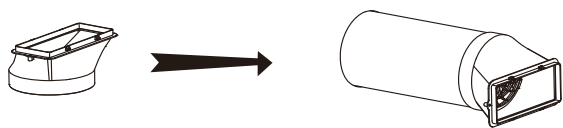

1. Attach the fishtail connector to the end of the hose, by extending the end and twisting until firmly attached (At least 3 full rotations).

2. Attach the connector on the opposite end of the pipe to the exhaust outlet on the rear of the appliance by putting into position and twisting to lock in place.

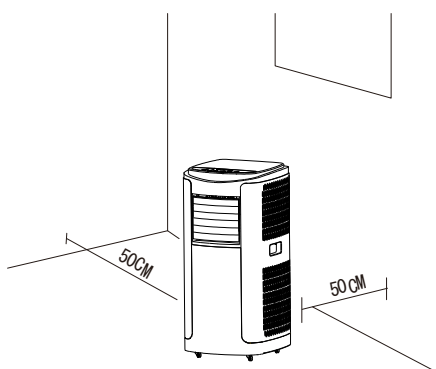
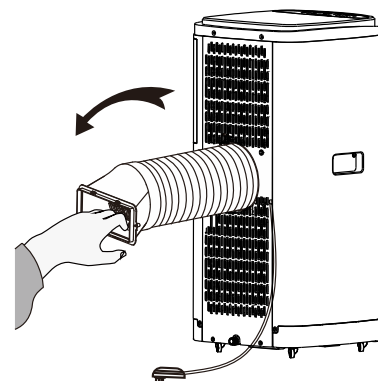

3. Make sure the unit is upright and there are no obstructions to the air inlets and outlet grills.

INSTALLATION OF WINDOW KIT

The window kit (slide bar and fishtail) can be used with sliding windows and doors. For other types of window, the fishtail should be used on its own.

1. Partially open the window and place the extended slide bar in position before closing the window onto it.

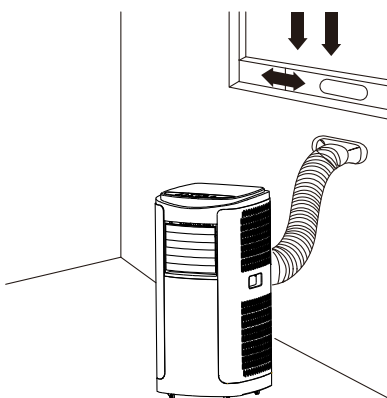
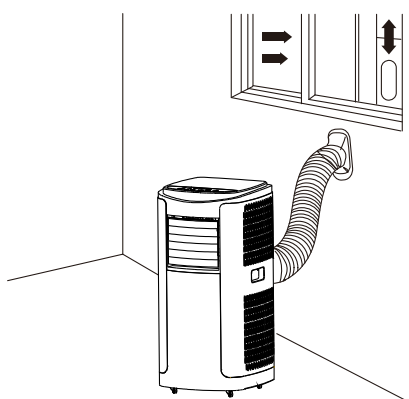
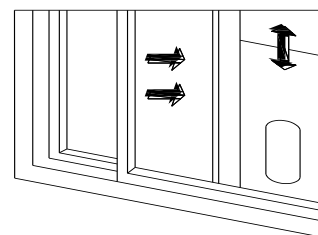
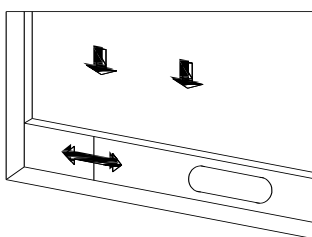

2. Fix the fishtail adaptor into the opening on the slide bar
3. Fix the exhaust connector on the opposite end of the exhaust hose to the exhaust outlet on the rear of the air conditioner.

NOTES:

- The window kit is only designed to be installed with sliding or sash windows or doors. The window kit is not designed or to be used with any other style of windows.
- The fish tail adaptor can be used without the slide bar with most windows / doors.
- When using the air conditioner ensure that the opening left around the fishtail is as small as possible as the cooling will be less efficient.
- The best form of installation is through a wall duct. By properly venting you expel hot air from your room while efficiently cooling it.
- Your air conditioner should be used without the vent pipe in dry mode. When using dry mode ensure that an external water tank is used, monitored and regularly emptied before overflowing. Permanent plumbing can be also installed for dry mode or an external uplift water pump can be set up for unattended use.

IMPORTANT SAFEGUARDS

The length of the soft hose extends from approximately 30 cm to 180 cm. If hose is extended above this length, the unit may malfunction which can invalidate the warranty. The outlet vent must be well ventilated and not obstructed as this will cause the unit to overheat. Keep the hose as straight and short as possible and avoid bending the air hose by more than 30 degrees in order to maintain the performance of the unit. Excessive bends in the hose may prevent the unit from expelling the hot air, which can lead to internal damage which would invalidate the warranty.

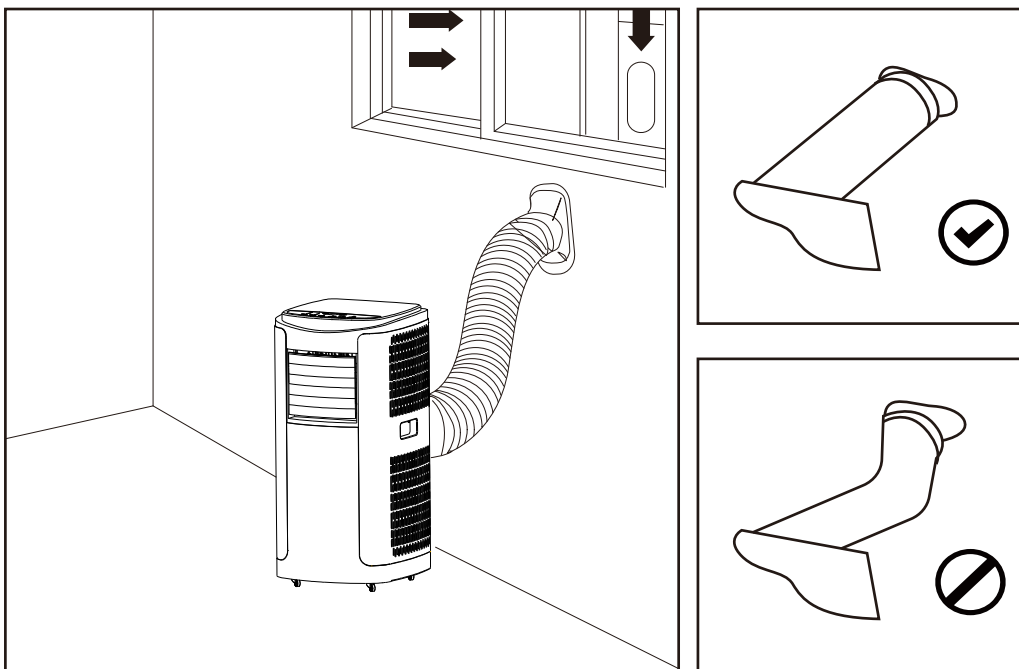

OPERATION

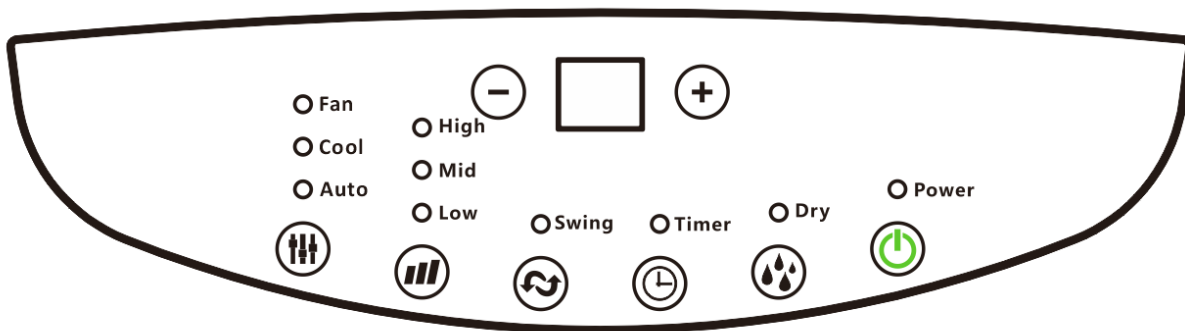

Press the POWER button to turn the unit ON or OFF.



Press the MODE button to cycle between the 3 modes, the indicator for the selected mode will be illuminated.

COOL: The room is cooled with the cold air expelled through the front air outlet while hot air is expelled through the vent pipe. The desired room temperature can be set between 16 and 32 degrees using the + and – buttons, and the fan speed can be changed using the SPEED button.

FAN: The fan speed can be changed pressing the SPEED button.

AUTO: An intelligent cooling mode where the fan speed is automatically adjusted based on the amount of cooling required. The fan speed cannot be manually changed in AUTO mode.



Repeatedly press the SPEED button to cycle through the three fan speeds. Each time the SPEED button is pressed, the indicator will change to show the currently selected speed. The fan speed can be changed between Low, Med and High.

The fan speed cannot be changed in DRY mode.



The timer functions cannot be combined or repeated.

POWER ON TIMER

With the appliance in standby, press the TIMER button to set the power-on timer. Use the + and - buttons to adjust the duration of the timer (1 to 24 hours). The Timer indicator will turn on and the unit will start after the selected number of hours.

POWER OFF TIMER

With the appliance running with the desired settings, press the TIMER button to set the power-off timer. Use the + and - buttons to adjust the duration of the timer (1 to 24 hours). The timer indicator will illuminate and the unit will stop after selected number of hours.



Used to adjust temperature in COOL mode and to set the duration of the TIMER. The buttons are not used in FAN or DRY modes.



DRY (DEHUMIDIFY)

The unit should be operated without the vent hose and with the unit set up for continuous drainage to remove moisture from the air. The unit will operate at low fan speed and will show the temperature of the room on the display.



Press this button to enable the swing function. When the SWING button is pressed again the louvres will stop in their current position. Do not attempt to adjust the angle of the blades manually.

REMOTE CONTROL

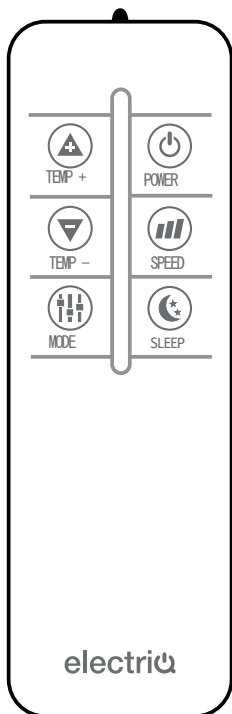

POWER	Press to turn the unit on or off.
TEMP -	Press to decrease the desired temperature or timer duration.
TEMP +	Press to increase the desired temperature or timer duration.
SPEED	Press to change between the three fan speeds.
SLEEP	Press the sleep button to enter sleep mode.
MODE	Press to change between Auto, Cool and Fan modes.

NOTE: The design of the remote may vary from the diagram, due to continuous product improvement.

MULTI PROTECTIVE FUNCTIONS

FROST PROTECTION

In COOL, DRY or AUTO modes, if the temperature of the exhaust is too low, the machine will automatically stop operating until the temperature has risen.

OVERFLOW PROTECTION

When the water in the internal water tank exceeds the warning level, the machine will stop operating and sound an alarm with the LCD display showing "E4". To resume operation empty the internal water tank. After the water is emptied, the machine will automatically return to the original state.

AUTO-DEFROST

The machine has automatic defrosting function. If during operation the temperature of the internal coils drops too low, the unit will enter a defrost cycle to prevent the build up of ice within the unit.

AUTOMATIC THERMAL PROTECTION

To protect the service life of the machine, the machine has automatic thermal protection. If the temperature within the unit is outside of the specified range, the compressor and the lower motor will stop operation. The appliance will automatically return to normal operation after the temperature of the machine recovers.

COMPRESSOR PROTECTION

To prevent damage to the compressor there is a 3 minute delay start protection function.

EMPTYING THE INTERNAL WATER TANK

MANUAL DRAINAGE:

When the internal water tank is full the unit will stop working. Shut off the unit and unplug. Try not to move the model abruptly as this may cause the water in the internal tank to spill out.

Place a tray under the lower water plug or place the unit in a drainage area.

Unscrew the drain plug cap and remove the rubber stopper - water will drain from the internal tank. Put the rubber stopper back and screw the drain plug cap back into place.

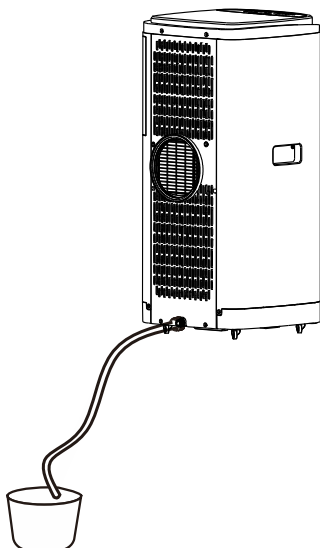
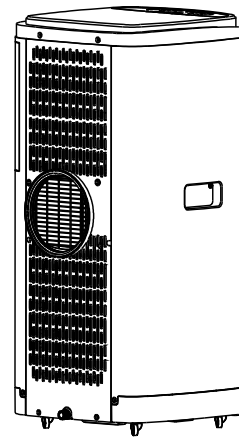

CONTINUOUS DRAINAGE:

Unscrew the drain plug cap and remove the rubber stopper.

Connect a water pipe to the upper water outlet.

You can plumb this pipe into your current plumbing system, lead it outside and use gravity fall or use a water pump.

NOTE: This model has a self-evaporative function, which reduces the need to empty the water tank. If the unit is vented correctly most of the water is reused to cool the condenser coils and any excess is evaporated. Please do not use continuous drainage if you intend to use the self-evaporating facility.

CLEANING AND MAINTENANCE

PLEASE TURN OFF THE UNIT AND UNPLUG FROM THE MAINS BEFORE CLEANING OR PERFORMING ANY MAINTENANCE

CLEAN THE SURFACE

Clean the surface of the machine with a wet soft cloth. Do not use chemicals, such as benzene, alcohol, gasoline, etc; otherwise, as this may cause damage to the surface and or the internal workings of the machine

AIR FILTER CLEANING

If the filter screen is clogged with dust, the effectiveness of the air conditioner is reduced. The filter screen should be cleaned once every two weeks or as often as necessarily in your environment.

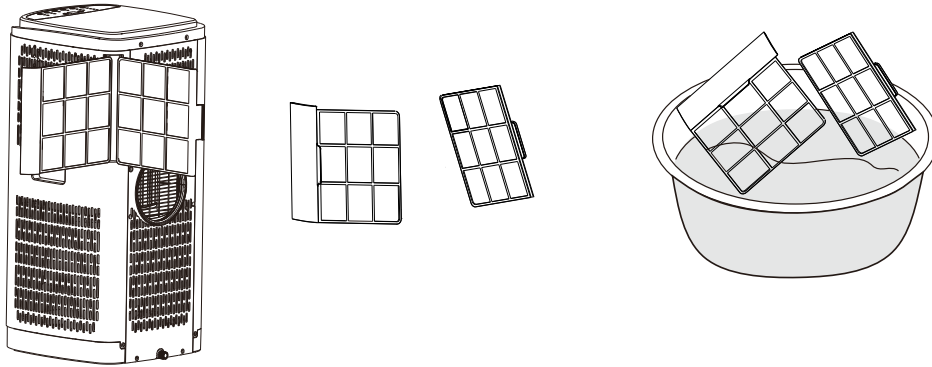

CLEAN THE UPPER FILTER SCREEN FRAME

Slide out the filter screen frames from the unit. If there are screws holding the filter in place these should be removed. The evaporator filter screen can be cleaned in warm water with neutral detergent (about 40°C / 104°F). It must be rinsed clean and dried in the shade before reinstalling in the unit.

CLEAN THE LOWER FILTER SCREEN FRAME

Hold the handle of the air inlet filter screen frame, and pull it outward gently to remove it.

Put the filter screen into warm water with neutral detergent (about 40°C / 104 °F). It must be rinsed clean and dried in the shade before reinstalling in the unit.

END OF SEASON MAINTENANCE

1. Remove the rubber stopper from the drainage hole and empty the internal tank. You can also drain the water by leaning the unit.
2. Then switch the unit to low fan mode.
3. Keep the unit in this mode for half day - until the conduit is dried. Doing this helps to keep the inside of the unit dry and prevents mould from developing
4. Turn off the unit and pull out the plug.
5. Replace the rubber stopper.
6. Coil the wire and bind it together, then put it into the accessories space.
7. Separate the air-exhaust pipe and store it safely.
8. Cover the unit and keep it in a dry place.
9. Take the batteries out of remote control and store or dispose of them safely. Keep all accessories with the unit ready for next season.

TROUBLESHOOTING

Do not repair or disassemble the air conditioning. Unqualified repair will invalidate the warranty and may lead to failure, causing injuries and property damage. Only use it as directed in this user manual and only perform operations advised here.

Problems	Reasons	Solutions
The air conditioner does not work.	There is no electricity.	Turn it on after connecting it to a socket with electricity.
	The display shows "E4".	Discharge the water inside.
	The ambient temperature is too low or too high	Only use to use the machine within temperature range of 7-35°C (44-95°F).
	In cooling mode, the room temperature is lower than the desired temperature	Change the desired temperature.
	In dry mode, the ambient temperature is low.	The ambient temperature must be above 16 °C. (60 °F).
The cooling effect is not good	There is direct sunlight.	Use curtains to reduce the direct sun heat
	Doors or windows are open; there are a lot of people; or in cooling mode, there are other sources of heat (e.g. fridges)	Close doors and windows; increase air conditioning power
	The filter screen is dirty.	Clean or replace the filter screen.
	The air inlet or outlet is blocked.	Clear obstructions; make sure venting is correct as described in this user manual and hose is not bent
Loud Noise	The air conditioning is not placed on a flat surface.	Put the air conditioning on a flat and hard place (to reduce noise).
Compressor does not work.	Overheat protection starts.	Wait for 3 minutes until the temperature is lowered, and then restart the machine.
The remote control does not work.	The distance between the machine and the remote control is too far.	Let the remote control get close to the air conditioner, and make sure that the remote control directly faces the receiver.
	The remote control is not aligned with the receiver.	
	Batteries are dead.	Replace batteries.
Others	No refrigerant or there is very little refrigerant	Refer to Service Centre (check leakage, welding, vacuum pump, charge refrigerant according to name plate)
	Anti-freezing protection	Waiting for defrosting. Function will recover automatically. No user input needed.
	High pressure protection	After inside gas pressure comes down, it will function normally. No user input needed

If problems not listed in the table occur or recommended solutions do not work, please contact the service centre.

ERROR CODES

CODE	CAUSE	SOLUTION
dH	Unit in dry mode	Not a fault, no action required.
E2	Room temperature sensor error	Room temperature is outside the operational range. Do not operate until the room is within the range required.
E4	Water full alarm	Empty the water tank
MODE LIGHT FLASHING	Cool / dry mode, the compressor has not started, the mode light will flash. This is normal	The unit will start operation when the protection period has finished (approx. 3 minutes)

APPENDIX

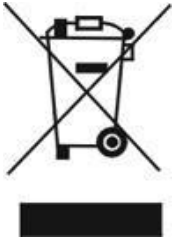

Disposal: Do not dispose this product as unsorted municipal waste. Collection of such waste must be handled separately as special treatment is necessary. Recycling facilities are now available for all customers at which you can deposit your old electrical products. Customers will be able to take any old electrical equipment to participating civic amenity sites run by their local councils. Please remember that this equipment will be further handled during the recycling process, so please be considerate when depositing your equipment. Please contact the local council for details of your local household waste recycling centres.

electriQ UK SUPPORT

www.electriQ.co.uk/support

Please, for your own convenience, make these simple checks before calling the service line. If the unit still fails to operate call the number below, or complete the online form.

0330 390 3061

1. Has the unit been standing upright for at least 2 hours?
2. Is the unit plugged into the mains?
3. Is the fuse OK?
4. Switch the unit off and wait three minutes to see if the issue is resolved. Restart the unit.
5. Check if the water tank is full.

Office hours: 9AM - 5PM Monday to Friday

www.electriQ.co.uk

Unit J6, Lowfields Business Park
Lowfields Way, Elland
West Yorkshire, HX5 9DA

TECHNICAL DATA

Model	P12C	P15C
Cooling capacity:	12,000 BTU	14,000 BTU
Input power:	1300 W	1500 W
Fan	AC motor with 3 fan speeds.	
Air flow volume:	420 m ³ /h	
Input current:	5.65 A	6.5 A
Refrigerant:	R290/280g	
Sound power level:	56 dB(A)	
Thermostat:	16-32°C	
Maximum working pressure of suction/exhaust side:	1.0/3.5 MPa	
Maximum Allowable Pressure	3.5 Mpa	
Power Supply:	AC 230V/50 Hz	
Net Weight:	27.5 kg	28 kg
Dimension(L*D*H):	506 x 525 x 838 mm	

Unit must be vented outside when in Air Cooling mode. For the purposes of EU regulation EN12102 this is a local air conditioner and produces less than 65dB(A) sound energy.



R 290